

DWA 2500



THE SMART SOLUTION IN 3D HD WHEEL ALIGNMENT

-  The perfect balance of convenience, easy use and quality
-  Il perfetto equilibrio fra convenienza, semplicità d'uso e qualità
-  L'équilibre parfait entre le prix, la simplicité d'utilisation et la qualité
-  Der perfekte Ausgleich zwischen Wirtschaftlichkeit, einfacher Anwendung und Qualität
-  El equilibrio perfecto entre conveniencia, facilidad de uso y calidad



CEMB

DWA 2500

- High definition cameras** height adjustable with manual controls
Quarterly updates of the data bank for clear, rapid selection of different versions of vehicles
- Telecamere ad alta definizione** regolabili in altezza con comando manuale
Aggiornamenti quadrimestrali della banca dati per una selezione rapida e chiara delle diverse versioni dei veicoli
- Caméras haute définition** réglables en hauteur avec commande manuelle
Mises à jour quadrimestrielles de la base de données afin de permettre la sélection rapide et claire des différentes versions de véhicule

- Manuell höhenverstellbare **Kameras mit hoher Auflösung**
Viermonatliche Aktualisierungen der Datenbank für eine schnelle und übersichtliche Auswahl der verschiedenen Fahrzeugversionen
- Cámaras de alta definición** de altura regulable con mando manual
Actualización cuatrimestral de la base de datos para una selección rápida y clara de las distintas versiones de los vehículos

SIMPLE AND USER FRIENDLY SOFTWARE

- Guided procedure** suitable for any worker, to guarantee performance and efficiency
Simple, intuitive graphics with rapid selection keys and icons
Quick, precise measurements with value adjustments in real time
Single raised wheel run-out for smaller workspaces or lifts with stairs
Audit Function: identification of driving problems, resulting from measures not contemplated in the specifications to support the regulation service
- Procedura guidata** alla portata di tutti per garantire resa ed efficienza
Grafica semplice e intuitiva con tasti di selezione rapida tramite icone
Misure rapide e precise con regolazione dei valori in tempo reale
Run-out a ruota singola sollevata nel caso di spazi di lavoro ridotti o di ponti con scalini
Funzione Audit: diagnosi dei disturbi di guida, conseguenti a misure fuori specifica, per supportare la vendita del servizio di regolazione
- Procédures guidées** à la portée de tous afin de garantir rendement et efficacité
Graphisme simple et intuitif avec des touches de sélection rapide à l'aide d'icônes
Mesures rapides et précises avec réglage des valeurs en temps réel
Mesure de l'excentricité à roue indépendante soulevée si l'espace de travail est réduit ou si le pont à des marches
Fonction Audit: diagnostic des problèmes de conduite à la suite de mesures hors spécification, pour supporter la vente du service de réglage





- Bedienerfreundlich **geführte Prozeduren**, um Leistung und Effizienz zu garantieren
Einfache und intuitive Grafik durch Schnellwahltasten mit Ikonen
Schnelle und präzise Messungen mit Einstellung der Werte in Echtzeit
Run-out am einzelnen angehobenen Rad bei Platzmangel oder Stufen-Hebebühnen
Funktion Audit: Die Diagnose der Fahrstörungen infolge von Messungen außerhalb der Toleranz erleichtert den Verkauf des Service zur Regulierung
- Procedimientos guiados** al alcance de todos para garantizar rendimiento y eficacia
Presentación gráfica sencilla e intuitiva con teclas de selección rápida con iconos
Medidas rápidas y precisas con ajuste de los valores en tiempo real
Desviación con una rueda levantada en lugares de trabajo con espacio reducido o puentes con escalones
Función Audit: diagnóstico de problemas de conducción debidos a medidas que no cumplen las especificaciones como argumento de venta del servicio de reglaje

TARGETS

- Compact Targets** with no electronics and batteries
- Bersagli compatti** senza elettronica e batterie
- Cibles compactes** sans électronique et batteries
- Kompakte Zielscheiben** ohne Elektronik oder Batterien
- Reflectores compactos** sin electrónica o baterías



CABINET

-  **Ergonomic design and easy accessibility** during maintenance operations
Industrial computer with Windows 10 and SSD memory, without moving disks more likely to break
WiFi connection for automatic software updates
-  **Design ergonomic e facile accessibilità** in caso di manutenzione
Computer industriale Windows 10 con memoria SSD, senza dischi in movimento più soggetti a rotture
Collegamento wifi per l'aggiornamento automatico del software
-  **Forme ergonomique et accès facile** en cas d'entretien
Ordinateur industriel Windows 10 avec mémoire SSD, sans disque en mouvement qui risquent davantage les ruptures
Connexion Wi-Fi pour la mise à jour du logiciel
-  **Ergonomisches Design** und leichter Zugang für Wartungsarbeiten
Industrieller Computer Windows 10 mit SSD-Speicher, ohne bewegliche Scheiben, dem stärkeren Bruch ausgesetzt sind
Wifi-Verbindung zur automatischen Aktualisierung der Software
-  **Diseño ergonómico y de fácil acceso** en caso de mantenimiento
Ordenador industrial Windows 10 con memoria SSD, sin discos móviles con más probabilidad de romperse
Conexión wifi para actualizar automáticamente el software

AVAILABLE IN TWO VERSIONS:



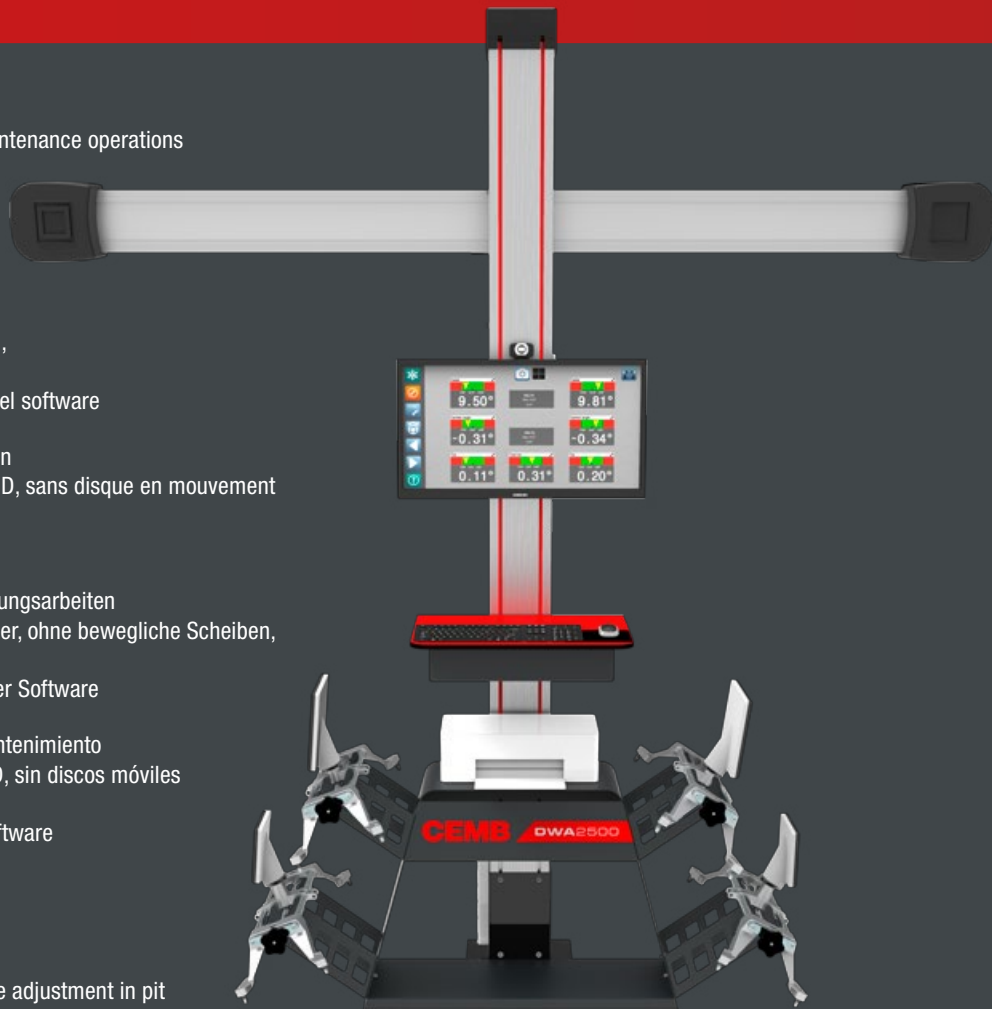

STANDARD with 27" monitor



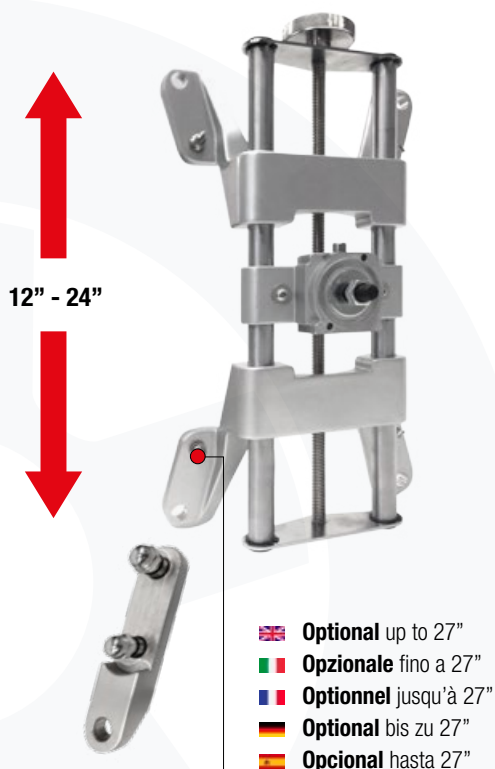

PIT supplied with an additional 21" monitor to ease the adjustment in pit



STANDARD CONFIGURATION







-  **Optional** up to 27"
-  **Opzionale** fino a 27"
-  **Optionnel** jusqu'à 27"
-  **Optional** bis zu 27"
-  **Opcional** hasta 27"





-  **Universal grips** with locking system
-  **Unghiette universali** con sistema di bloccaggio
-  **Onglets universels** avec système de blocage
-  **Universalradklammerfinger** mit Spannsystem
-  **Uñas universales** con sistema de bloqueo

OPTIONAL ACCESSORIES



-  **Premium turntables:** capacity 1000 kg per plate, diameter 35 cm, with rubber supports
-  **Piatti Premium:** portata 1000 kg per piatto, diametro 35 cm, con supporti in gomma
-  **Plateaux Premium:** portée 1000 kg par plateau, diamètre 35 cm, avec supports en caoutchouc
-  **Premium-Teller:** Tragkraft 1000 kg pro Teller, Durchmesser 35 cm, mit Auflagen aus Gummi
-  **Platos Premium:** capacidad de 1000 kg por plato, 35 cm de diámetro, con soportes de goma



-  **Frontal assistance video camera** to help get onto the lift
-  **Videocamera frontale di aiuto** alla salita sul ponte
-  **Caméra vidéo frontale d'aide** à la montée sur le pont
-  **Vordere Hilfs-Videokamera** an der Auffahrt der Hebebühne
-  **Videocámara delantera de ayuda** para subir al puente

STANDARD COMPOSITION

🇬🇧 Cabinet

Computer with WINDOWS 10 operating system
27" TFT monitor, colour printer, USB keyboard, mouse, wifi pen drive
Four 4-point clamps 12"-24" with universal grips and targets
Camera support with manual control
Two mechanical turntables for cars
Brake pedal lock, steering lock
Wheel alignment software and database for CARS

🇮🇹 Armadio

Computer con sistema operativo WINDOWS 10
Monitor 27" TFT, stampante a colori, tastiera USB, mouse, chiavetta wifi
Quattro agganci a 4 punti 12"-24" con unghiette universali e bersagli
Supporto camere con comando manuale
Coppia di piatti meccanici per auto
Premipedale, blocca sterzo
Software e database autoveicoli

🇫🇷 Armoire

Ordinateur avec système d'exploitation WINDOWS 10
Moniteur 27", imprimante couleur, clavier USB, souris, clé wifi
Quatre griffes à 4 points 12"-24" avec onglets universels et cibles
Élévateur caméras avec contrôle manuel
Deux plateaux pivotants mécaniques pour voitures
Presseur pédale, blocage direction
Logiciel et base de données pour autos

🇩🇪 Steuerschrank

Computer mit Betriebssystem WINDOWS 10
27"-TFT-Monitor, Farbdrucker, Tastatur USB, Mouse, Wifi-Stick
4 Radklammern mit 4 Kontaktpunkten (12-24") mit
Universalradklammerfingern und Zielscheiben
Manuell bediente Halterung für Kameras
Zwei mechanische Drehplatten für PKW
Pedalbetätigung, Lenkradfeststeller
Software und Database für Fahrzeugen

🇪🇸 Mueble

Ordenador con sistema operativo WINDOWS 10
Monitor 27" TFT, impresora de color, teclado USB, ratón, memoria wifi
Cuatro garras de 4 puntos de 12-24" con uñas universales y reflectores
Soporte de cámaras con mando manual
Dos placas giratorias mecánicas para automóviles
Bloqueo de volante, depresor de freno
Software y base de datos para coches

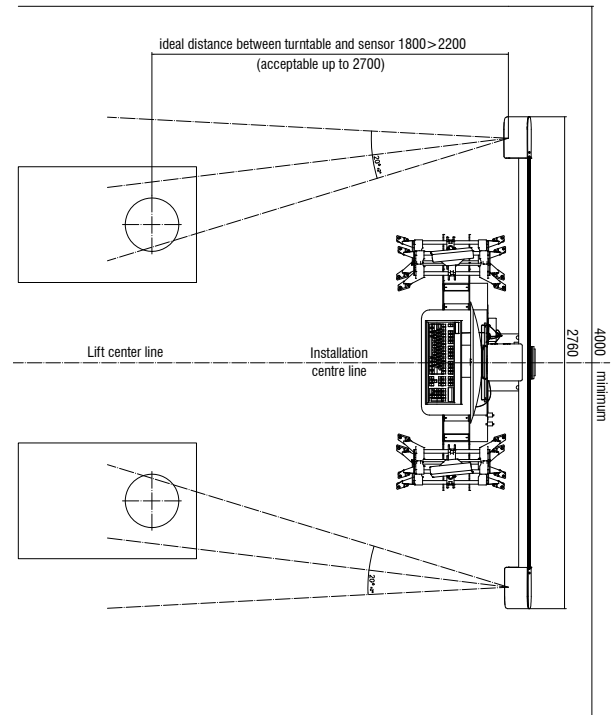
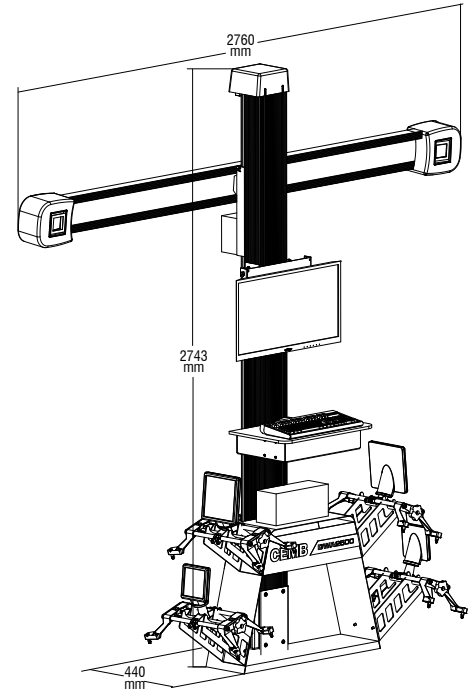

Available only in selected countries
Disponibile solo in paesi selezionati
Disponible seulement dans pays sélectionnés
Nur in ausgewählten Ländern erhältlich
Disponible sólo en los países seleccionados



CEMB

BALANCING MACHINES

CEMB S.p.A.

Via Risorgimento, 9
23826 Mandello del Lario (LC) - Italy

www.cemb.com



Garage equipment division

CEMB - ITALY

Plant and Training Center

Phone +39 0341 706111

garage@cemb.com

CEMB USA - BL Systems Inc.

2873 Ramsey Road
Gainesville, GA 30501 - USA

Phone +001 678 717 1050

Fax +001 678 717 1056

sales@cemb-usa.com



All the data and features mentioned in this catalogue are purely for information and do not constitute any commitment on the part of our company, which reserves the right to make any and all alterations it may consider suitable without notice.